

USAI® Lighting

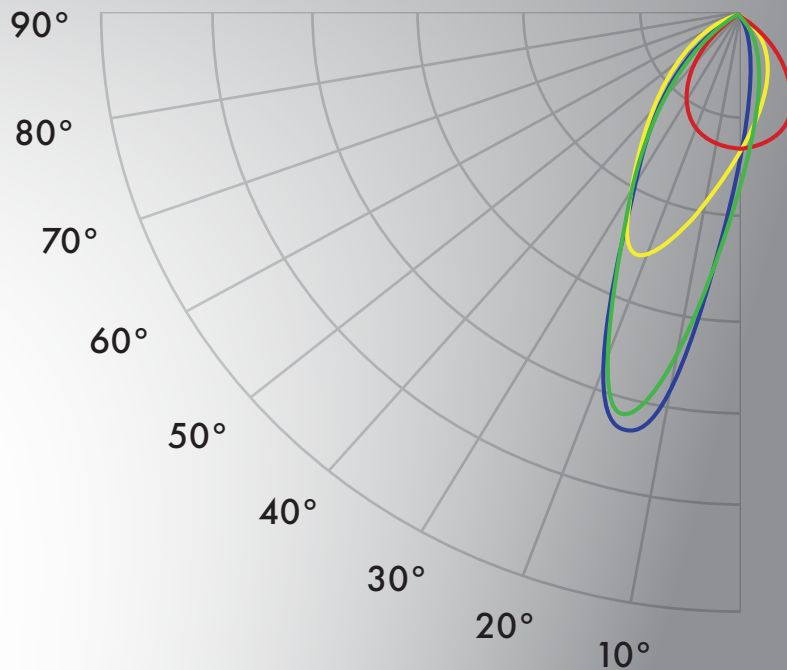

TrueZero³⁶⁰™

APPLICATION GUIDE

**Choose What You See.
Light Where You Want It.**

TrueZero³⁶⁰

SHHUSHED BY QUIET COMFORT™ OPTICS

TrueZero³⁶⁰ offers 360° comfort from every viewing angle in a space. USAI's innovative recessed lighting aesthetic and patented 5-part Quiet Comfort Optics system delivers over 2500 glare-free lumens. This application guide demonstrates how the perfect balance of performance and comfort can be achieved in your next project with the full TrueZero360 product family.

PICTURED ABOVE

Truly Zero 00" Regress
Wall Wash

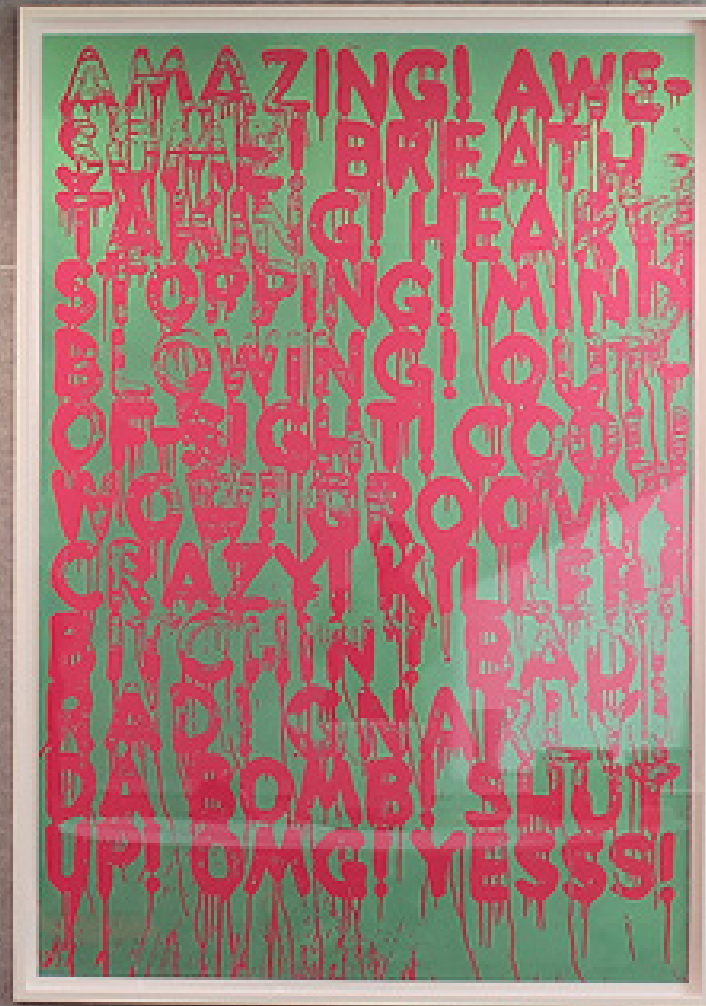

CONTENTS

FULL FAMILY
PLATFORM

03

WALL WASH

05

DOWNLIGHT

09

ADJUSTABLE

13

OPTICAL
FEATURES

17

HOUSING
OPTIONS

19

RELATED
PRODUCTS
FAQS

21

TrueZero³⁶⁰™

HIGH PERFORMANCE FEATURES AND SPECIFICATIONS

APERTURE
3"

SHAPE
Square

GLARE CONTROL
Minimum UGR is Less than 1

WATTAGE
9W, 12W, 15W, 18W, 20W, 29W

BEAM SPREADS
25°, 30°, 35°, 45°, 60°, 65° Beam Spreads with TIR Options + Wall Wash

TRIM OPTIONS
Truly Zero 00" Regress, Trimless, Millwork
Truly Subtle 3/8" Regress Trimmed, Trimless, Millwork

THE POWER
Truly Zero 00" Regress up to **2425** Delivered
Truly Subtle 3/8" Regress up to **2575** Delivered Lumens

HOUSING
Flat, New Construction, Insulation Contact,
Chicago Plenum Housing Options

 **Classic White®**
2700K, 3000K, 3500K, 4000K, 80+ and 90+ CRI

 **Warm Glow® Dimming**
2700K-2200K, 3000K - 2200K, 80+ and 90+ CRI

 **Color Select® Tunable White**
6000K-2200K, Tunable White Light 80+ CRI
4800K-2700K, Tunable White Light 90+ CRI

 **Infinite Color+**
Dynamic Color + White, 1600K-12,000K



IBEW Union
Made



Meets WELL
Building Standards



0.1% Dimming
Options



Dry, Damp,
Wet Locations



5 Year
Warranty



Buy American
Act Compliant



NRTL/CSA-US
Listed

Flush Glass and Regressed Glass Trims Without Glare

Truly Zero - 00" Regress

Designed for the ultimate quiet ceiling experience, this trimless fixture's glass aligns with the ceiling plane and appears to float gracefully with one singular identity for downlight, wall wash and adjustable options. Available in trimless and millwork.

Truly Subtle - 3/8" Regress

Designed with an ultra quiet 3/8" regress to create a separation of light that appears to sit deeper above. The visual result is a sophisticated level of detail in the ceiling with downlight, wall wash and adjustable options. Available in trimmed, trimless and millwork.

**Downlight, Adjustable
00" Regress
Trimless or Millwork**



White Edge Detail



Black Edge Detail

**Downlight, Adjustable
3/8" Regress
Trimless or Millwork**



White Baffle

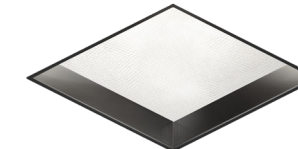

Black Baffle

**Downlight, Adjustable
3/8" Regress
Trimmed**



White Baffle, White Flange

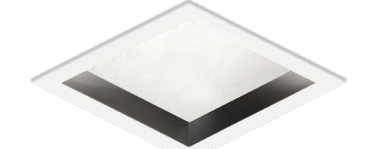

Black Baffle, White Flange

**Wall Wash
00" Regress
Trimless or Millwork**

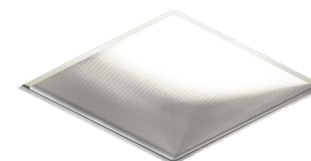

White Edge Detail

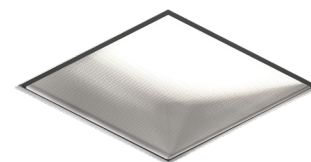

Black Edge Detail

**Wall Wash
3/8" Regress
Trimless or Millwork**



White Baffle

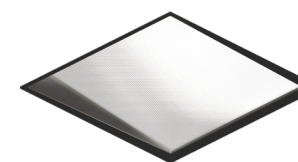

Black Baffle

**Wall Wash
3/8" Regress
Trimmed**



White Baffle, White Flange

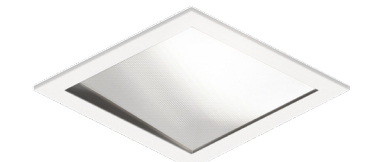

Black Baffle, White Flange

WALL WASH

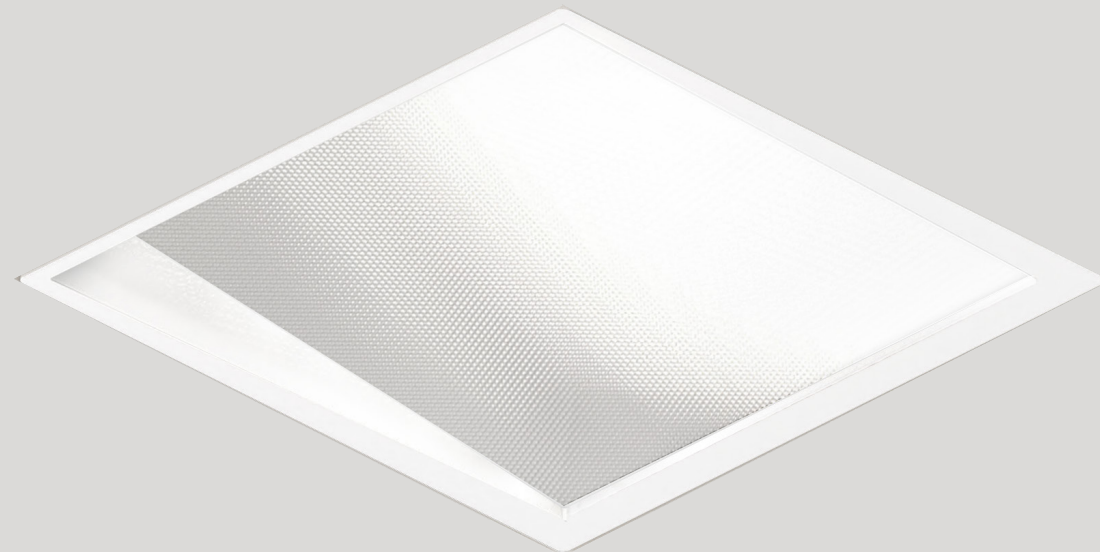

INCREASED EFFICIENCY

82%

light on the wall, eliminates backlight and scatter providing minimal waste and more light on the wall.

EVEN LIGHT DISTRIBUTION

Lights evenly from top to bottom.

EXPANDED USABILITY RANGE

Place fixture as close as to **12"** to the wall without compromising performance - no puddles of light.

VERTICAL ILLUMINATION

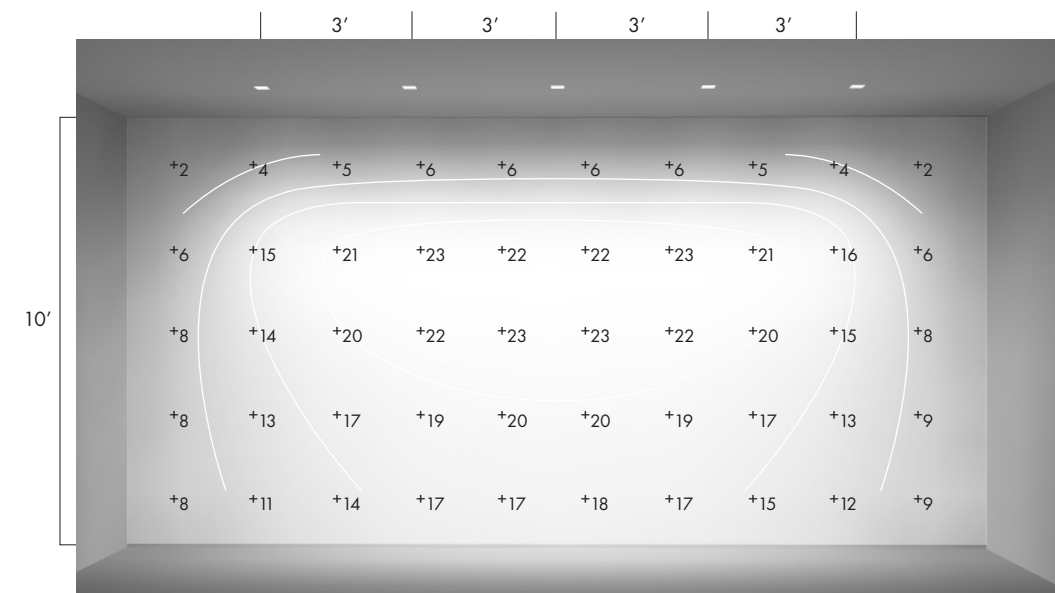

Vertical light makes spaces feel bright and inviting. The TrueZero³⁶⁰ wall wash is superior when it comes to applying light to walls. Place fixtures 3' apart and 3' off the wall in this 10' ceiling height space to achieve beautiful uniformity without backlight, scatter, or spilling light onto neighboring areas.

CIRCULATION LIGHTING WITH WALL WASH

Clearly illuminate corridors for navigation and promote wayfinding with light. In this typical 6' wide corridor, the **TrueZero³⁶⁰ Wall Wash** is aimed at the opposite wall to emphasize the vertical plane and create a sense of spaciousness. Additionally, the light on this wall provides indirect lighting on the floor, ensuring safe and comfortable transitions from space-to-space.

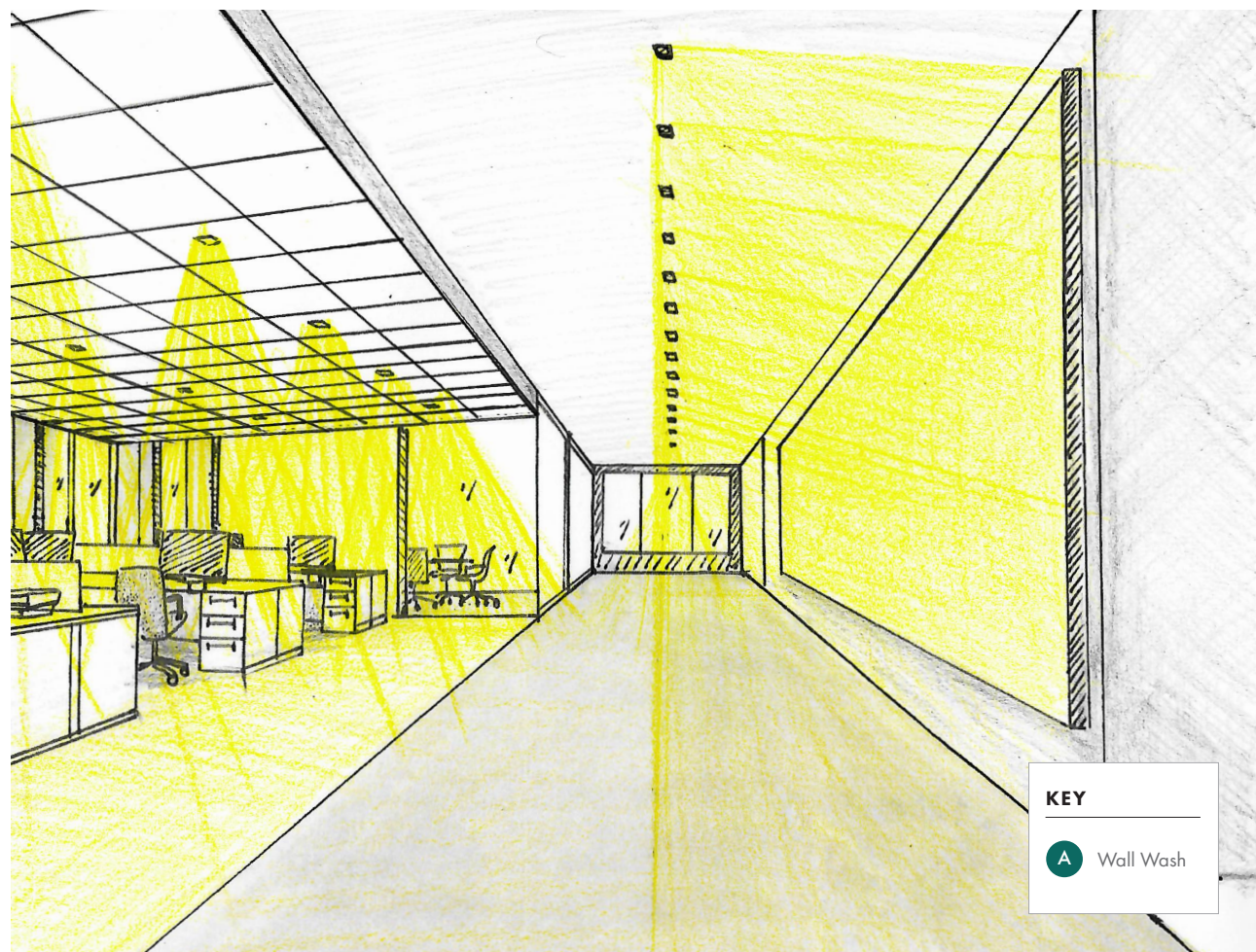

LAYER **A** SPECIFICATION:

Wall Wash

FIXTURE SPEC: Z3SWL-00-20L3-35KS-W4-SD4

WATTAGE: 20W

COLOR TEMPERATURE: 3500K, 80+ CRI

DELIVERED LIGHT: 1023 Lumens

EFFICIENCY: 50 Lumen/Watt



FIXTURE LOCATION FLEXIBILITY

In the application shown below, we demonstrate that the **TrueZero³⁶⁰ Wall Wash** can be spaced 3' on center in a 9' ceiling to achieve the above recommended IES light levels in the corridor. Even when the wall wash fixtures are installed as close as 12" away from the wall, the light will still illuminate the wall evenly from top to bottom, whereas other fixtures may create bright spots. The suggested distance is 24" -36" away from the wall for 8' to 12' walls.

ELEVATION VIEW

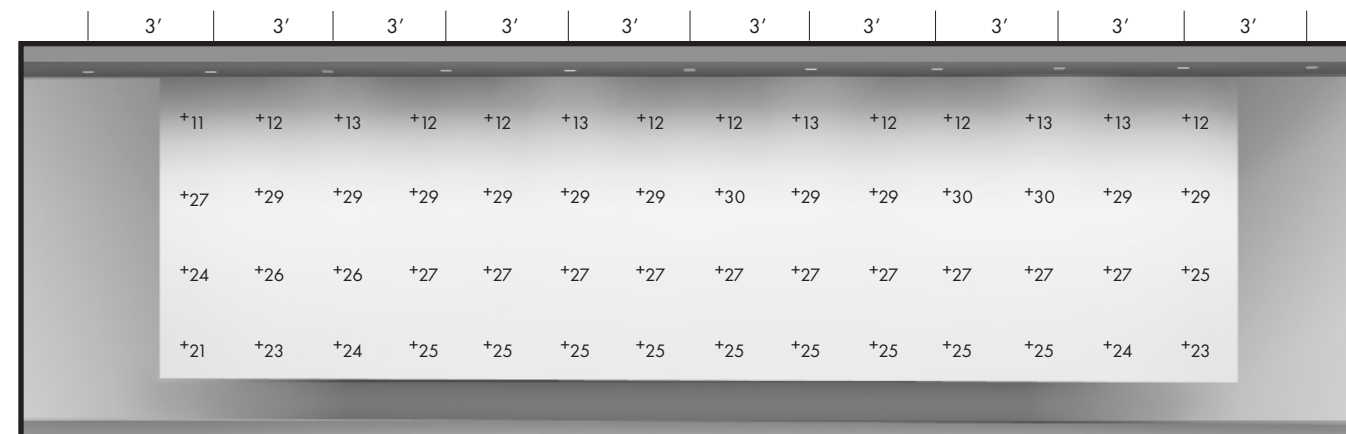

LIGHTING INTENSITY

Avg On Artwork: 21.4 FC
Max/Min On Wall: 4.7

Avg On Floor: 32.8 FC
Max/Min On Floor: 3

CORRIDOR DIMENSION:

6'W x 40'L x 9'H
Wall Offset: 3'

NOTE: Light level calculations reflectance values use standard 20% for floors, 50% for walls, and 80% for ceilings.

Wall Wash Distribution

The **TrueZero³⁶⁰ Wall Wash** features USAI's Quiet Comfort™ Optics, a patented 5-part optical system with superior task efficiency that delivers over 82% of all light emitted by the fixture onto the wall. The result is supremely efficient vertical lighting with minimal backlight and scatter.

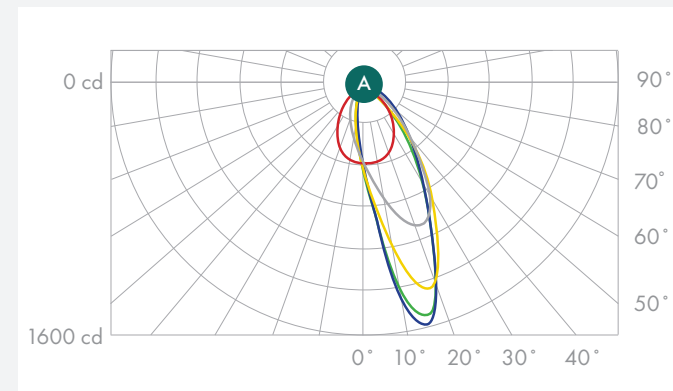

DOWNLIGHT

The Best Choice for Seamlessly Integrated Ambient Lighting

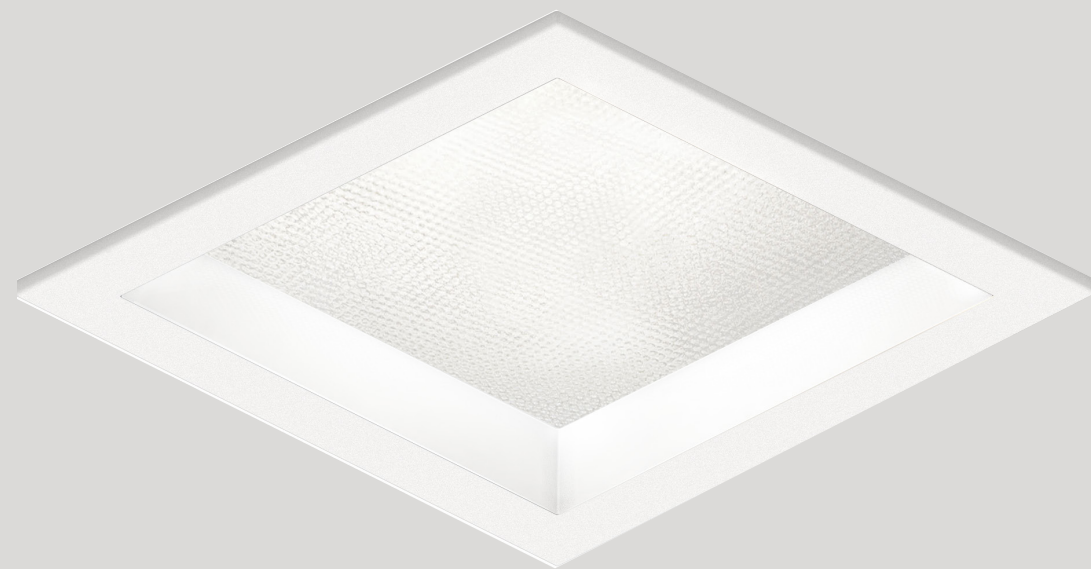

Design Features Include

- Provides a slight glow when illuminated; completes the ceiling when unlit - no black holes
- Straight baffle sides for low brightness and smooth beam control
- Choose from black, white, or white + black finish options to match any interior aesthetic

DOWNLIGHTS WITH SUPERIOR GLARE CONTROL

OVER 2500 DELIVERED LUMENS

HIGH PERFORMANCE

Delivers as much light as larger fixtures with superior optical design



QUIET CEILINGS

Minimal glare and scatter re-establishes the texture in a space and provides comfort at all angles.



MODERN LIGHTING

Upgrade your space with seamless ceilings and a clean trim aesthetic

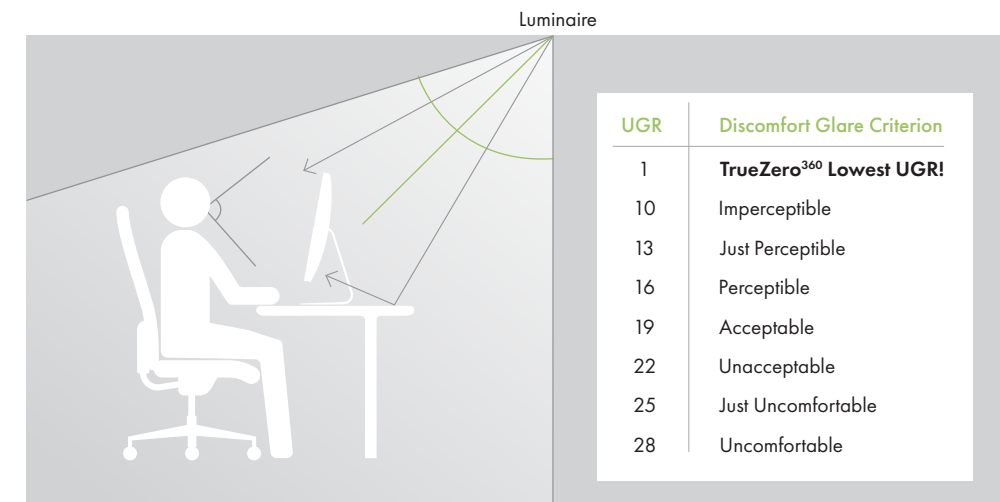

TrueZero³⁶⁰ downlights provide excellent general illumination while minimizing brightness and maximizing visual comfort. USAI can provide UGR values for every specification and help projects meet LEED(<19) and WELL(<19) requirements for glare control.

LIGHT FOR THE OPEN OFFICE

Light up open office spaces for focus, collaboration, and work. By installing the **Truly Subtle 3/8" Regress** fixture with a 6' x 6' spacing in an 8' high ceiling, we achieve the average recommended light levels on all surfaces with an outstanding low glare score.



LAYER A SPECIFICATION:

Downlight

FIXTURE SPEC: Z3SDF-38-20L3-35KS-60-S-BW

BEAM ANGLE: 60°

WATTAGE: 20W

COLOR TEMPERATURE: 3500K, 80+ CRI

DELIVERED LIGHT: 1565 Lumens

EFFICIENCY: 76 Lumen/Watt

GLARE (UGR): 16.9

Truly Subtle 3/8" Regress
Downlight,
Trimmed

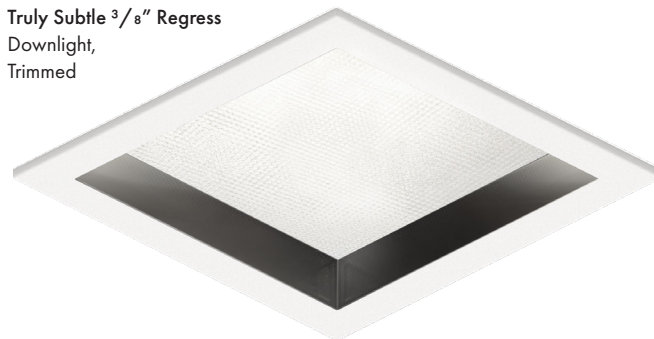

EXCELLENT POWER WITH MINIMAL GLARE

Below we show a plan view of the lighting calculation for the open office. Here we can demonstrate that the **TrueZero³⁶⁰** downlight can deliver 44 foot candles on the work-plane and over 20 foot candles on the floor when installed in a 8' high ceiling and spaced 6' apart. These light levels meet IES recommendations and provide plenty of illumination for computer work, reading, writing and more – making for a productive and comfortable workplace.

FLOOR PLAN

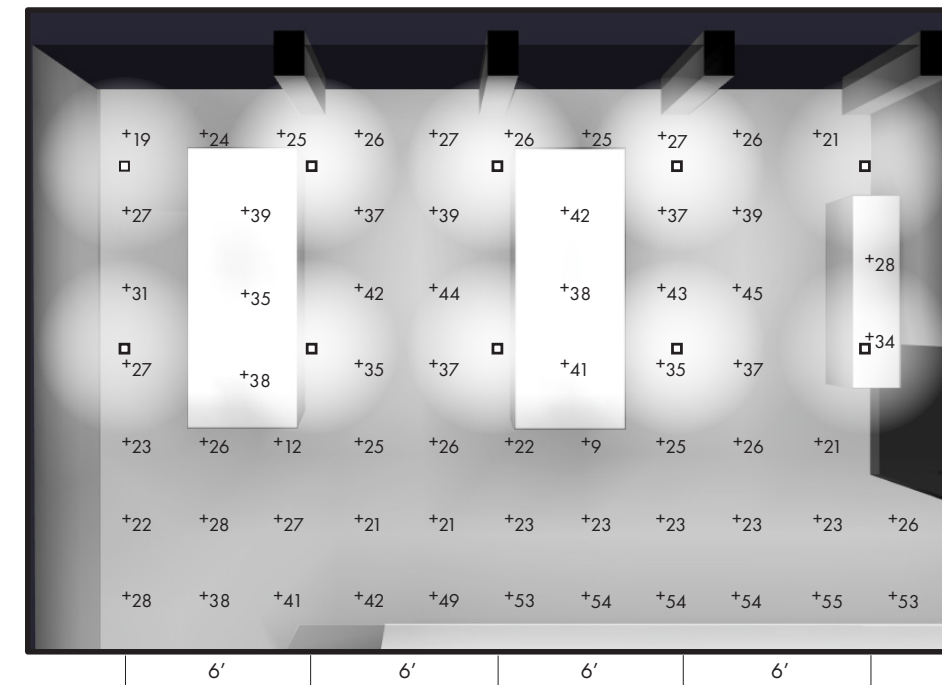

← LIGHTING INTENSITY

Avg On Floor: 37.8 FC
Max/Min On Floor: 3

Avg On Desk: 29.25 FC
Max/Min On Desk: 1.3

ROOM DIMENSION:
15'W x 30'L x 8'H

TABLE DIMENSION:
4'W x 10'L x 2'-6"H

NOTE: Light level calculations reflectance values use standard 20% for floors, 50% for walls, and 80% for ceilings.

60° Beam Distribution

The 60° beam distribution specified with **TrueZero³⁶⁰** provides a smooth and even illuminance on the work-plane and floor, with excellent uniformity.

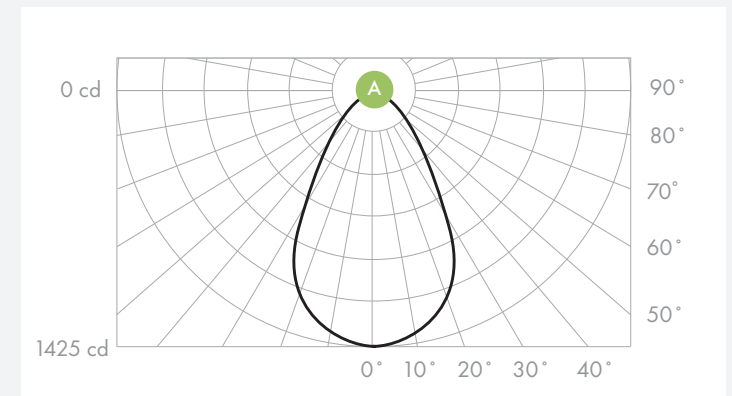

ADJUSTABLE

The Perfect Product for Accents and Highlights



Design Features Include

- Seamless, monolithic finished ceiling
- Shared below-the-ceiling appearance across fixture functions – downlight, wall wash and adjustable

FULL ADJUSTABILITY FREEDOM

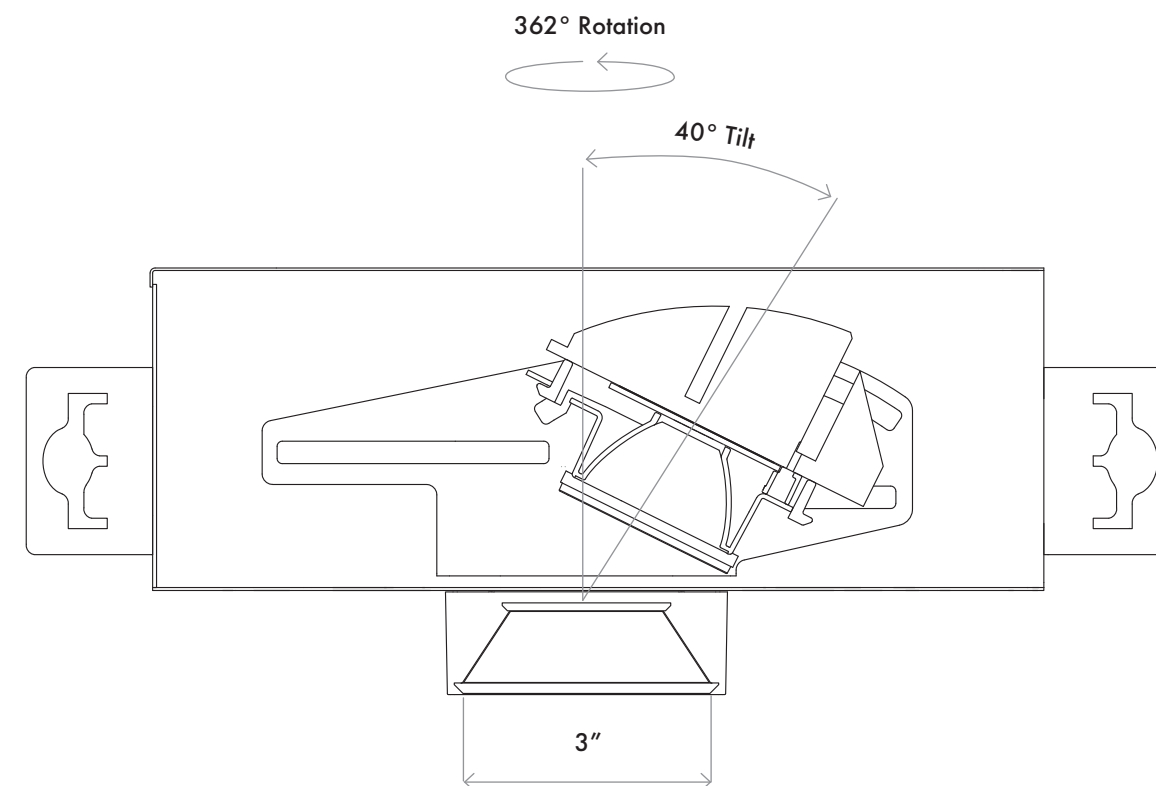

TrueZero³⁶⁰ Adjustable fixtures can be rotated 362° and tilted up to 40° maximum to highlight art and favorite objects. Field interchangeable optics, beam spreads from 25° to 50°, and lockable tilt and rotation offer the utmost flexibility for lighting design.

LIGHT FOR HOME

In this residential space, we show the TrueZero³⁶⁰ Adjustable provides general illumination for living areas. Accent art and family photographs placed on walls, or highlight coffee tables, throw pillows and other objects of interest – all with a consistent below-ceiling aesthetic. A wide range of beam options offers flexibility and convenience while maintaining superior brightness control for maximum comfort.

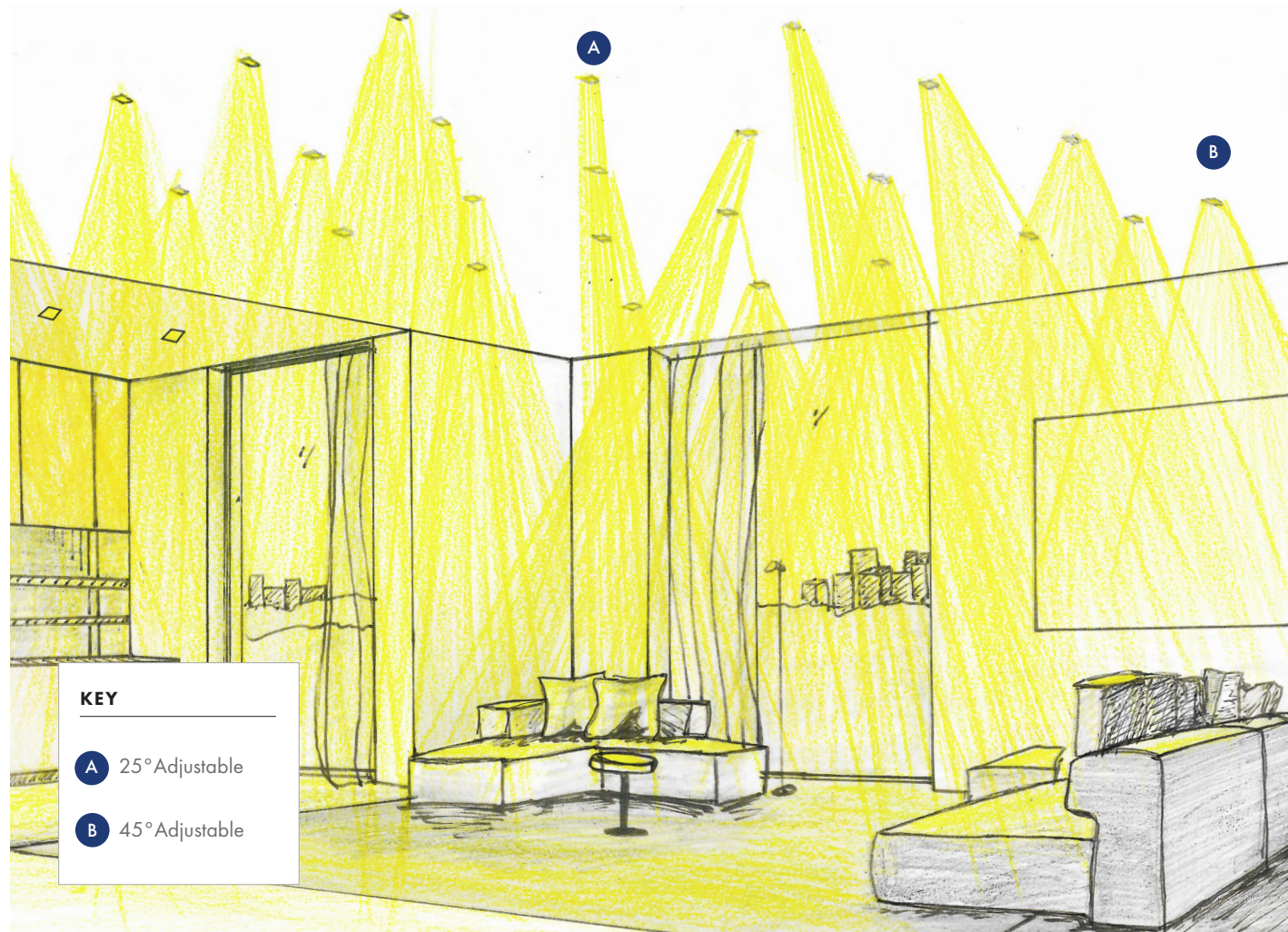

KEY

- A 25° Adjustable
- B 45° Adjustable

LAYER A SPECIFICATION:

- FIXTURE SPEC:**
Z3SAL-00-20L3-27KH-T25-S-WH
- BEAM ANGLE:** 25°
- WATTAGE:** 20W
- COLOR TEMPERATURE:**
2700K, 90CRI
- DELIVERED LIGHT:** 1437 Lumens
- EFFICIENCY:** 75 Lumen/Watt
- GLARE (UGR):** <1

LAYER B SPECIFICATION:

- FIXTURE SPEC:**
Z3SAL-00-20L3-27KH-T45-S-WH
- BEAM ANGLE:** 45°
- WATTAGE:** 20W
- COLOR TEMPERATURE:**
2700K, 90CRI
- DELIVERED LIGHT:** 1143 Lumens
- EFFICIENCY:** 60 Lumen/Watt
- GLARE (UGR):** 0.5

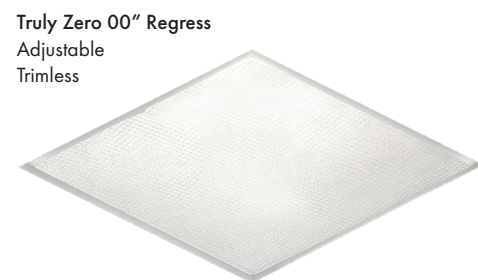

Highlight Artwork & Furniture

In this residential space, we show the TrueZero³⁶⁰ Adjustable provides highly dynamic and versatile illumination for living areas. Medium beam fixtures are utilized to highlight wall art and photographs, while narrow beam fixtures are directed towards pillows and specific furniture pieces, introducing dynamic range and visual interest to the space.

FLOOR PLAN

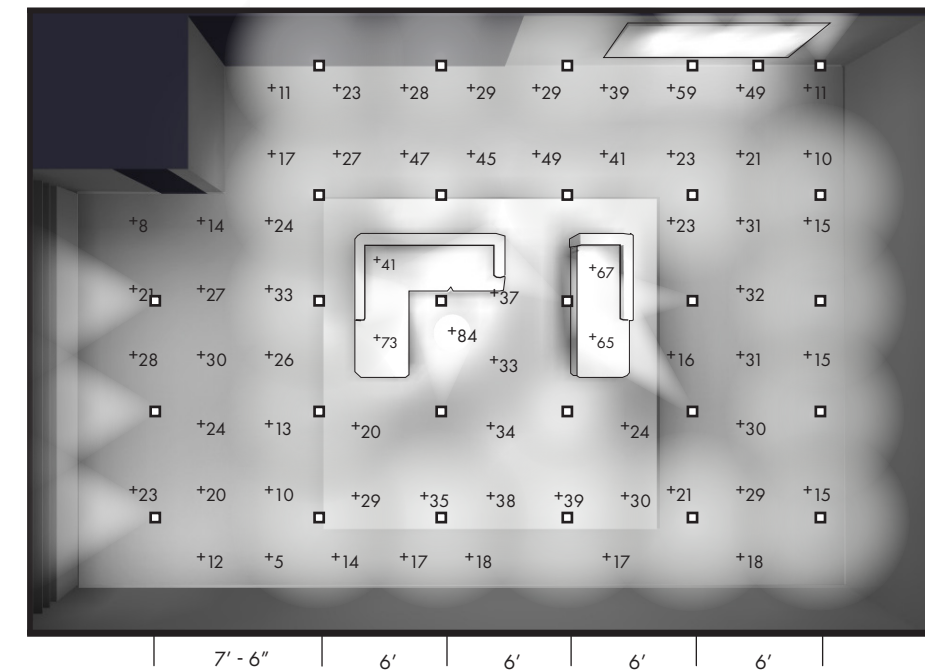

← **LIGHTING INTENSITY**

Avg On Floor: 23.17 FC
Avg/Min On Floor: 4.63

Avg On Feature Wall: 51.83 FC
Avg/Min On Feature Wall: 1.10

ROOM DIMENSION:
20'W x 20'L x 10'H

NOTE: Light level calculations reflectance values use standard 20% for floors, 50% for walls, and 80% for ceilings.

25° and 45° Beam Distributions

Both narrow and medium beams are used in this space with TrueZero³⁶⁰ Adjustable to produce a dynamic light level effect.

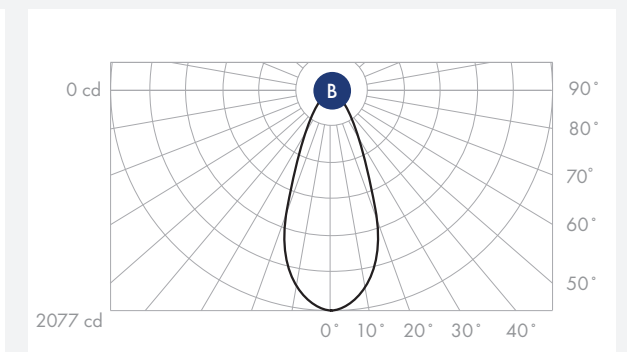
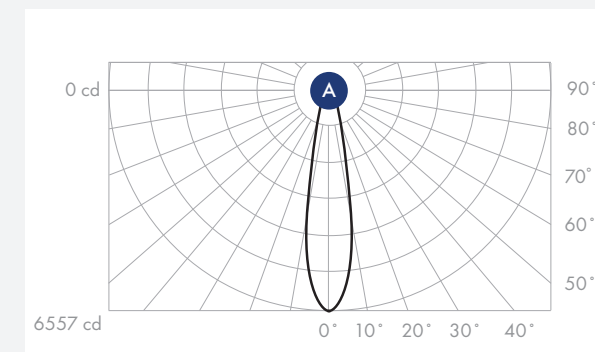

Quiet Comfort™ Optics

USAI invested in a very deliberate use of optics and engineering to place light where you want it. The TrueZero³⁶⁰ light fixture was designed with a lofty vision to reach specific high-achieving performance goals. Through a great deal of research and development, USAI created a 5-part patented optical system to deliver that result – **Quiet Comfort Optics**.

Our innovative reflector and lens combination keeps the light focused and framed into a beam to prevent scatter and unwanted brightness from bouncing back into the space. This reduces glare, backlight, and maintains a subtle luminance on the lens face so that the entire assembly disappears into the light. The TrueZero³⁶⁰ wall wash fixture boasts superior application efficiency, with over **82% of light output** illuminating the wall. Downlight optics are provided with an inner baffle to control glare.

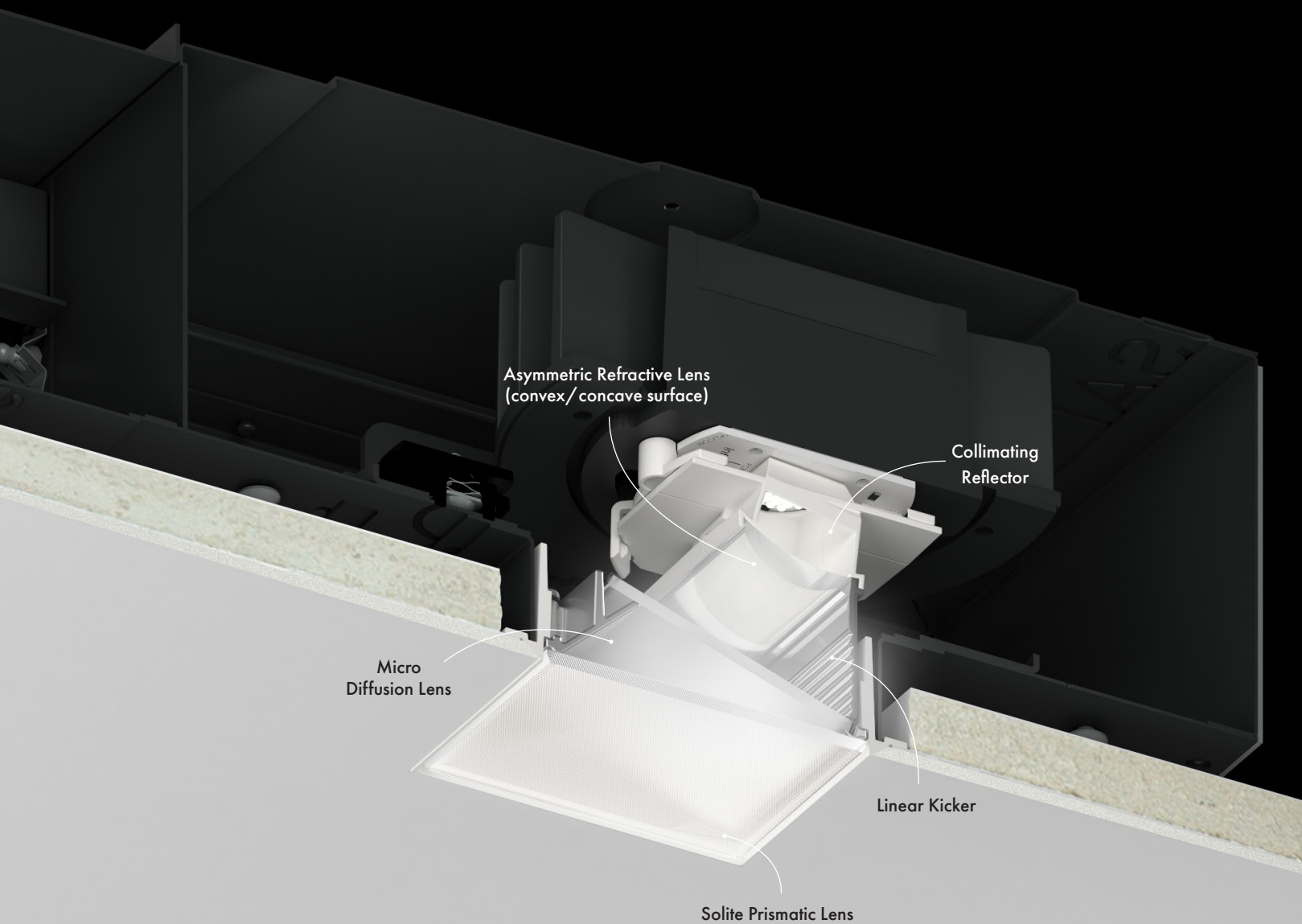

Truly Zero 00" Regress
Wall Wash

EXPERIENCE ALL THE COLOR POSSIBILITIES

USAI Lighting engineers are the trailblazers who innovated new possibilities and tools that were never before available – offering white color temperatures ranging from 2200K to 6000K. These patented technologies offer design opportunities only limited by the imagination and include, **Classic White®**, **Color Select®**, **Warm Glow® Dimming**, and **Infinite Color+®**.



Classic White®

2700K, 3000K, 3500K, 4000K, 80+ and 90+ CRI



2700K DAY



3000K DAY



3500K DAY



4000K DAY



Warm Glow® Dimming

2700K-2200K, 3000K - 2200K, 80+ and 90+ CRI



100% INTENSITY AT 3000K



45% INTENSITY AT 2700K



18% INTENSITY AT 2200K



Color Select® Tunable White

6000K-2200K, Tunable White Light 80+ CRI, 4800K-2700K, Tunable White Light 90+ CRI

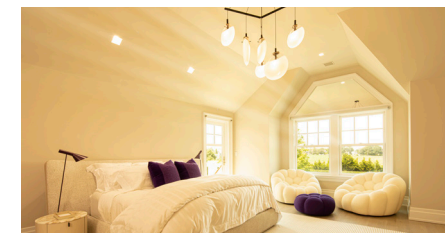

3600K, 80% INTENSITY



4800K, 70% INTENSITY



2400K, 50% INTENSITY



Infinite Color+®

Dynamic Color + White, 1600K-12,000K



FULL DYNAMIC COLOR



VIOLET ENERGY



NEUTRAL LOUNGE

TrueZero³⁶⁰TM

SMALLEST HOUSING OPTION DETAILS

DOWNLIGHT

Flat Housing - FT
IC and CP rated housing options available

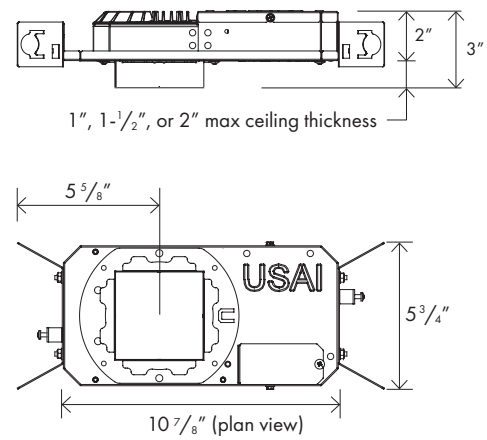

WALL WASH

Flat Glass Housing - FG
IC and CP rated housing options available

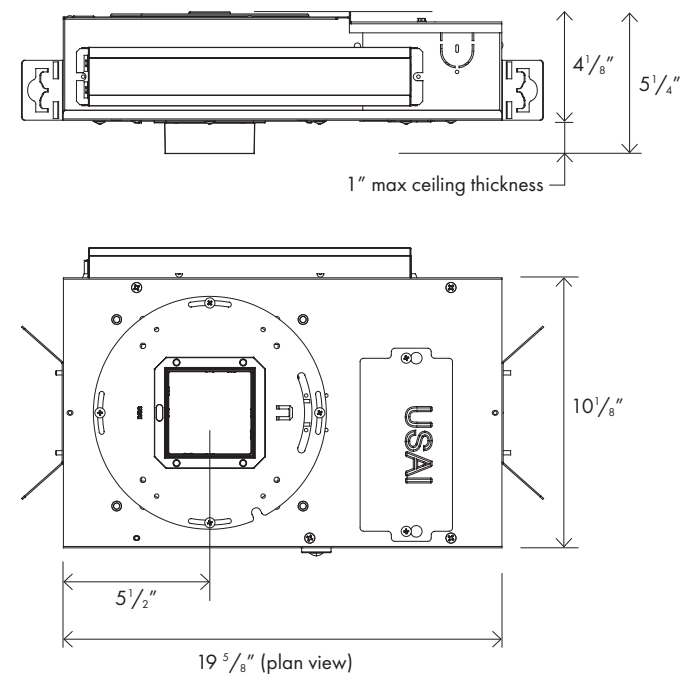

ADJUSTABLE

Flat Adjustable Housing - FTA2
IC and CP rated housing options available

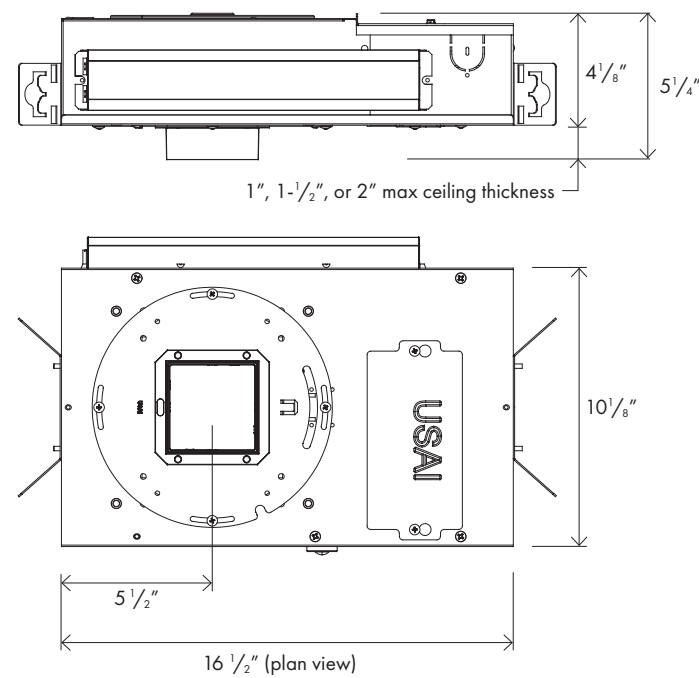

TIP: Use USAI's orange gasket (provided for trimless fixtures) to create cleaner ceiling spackle installations.

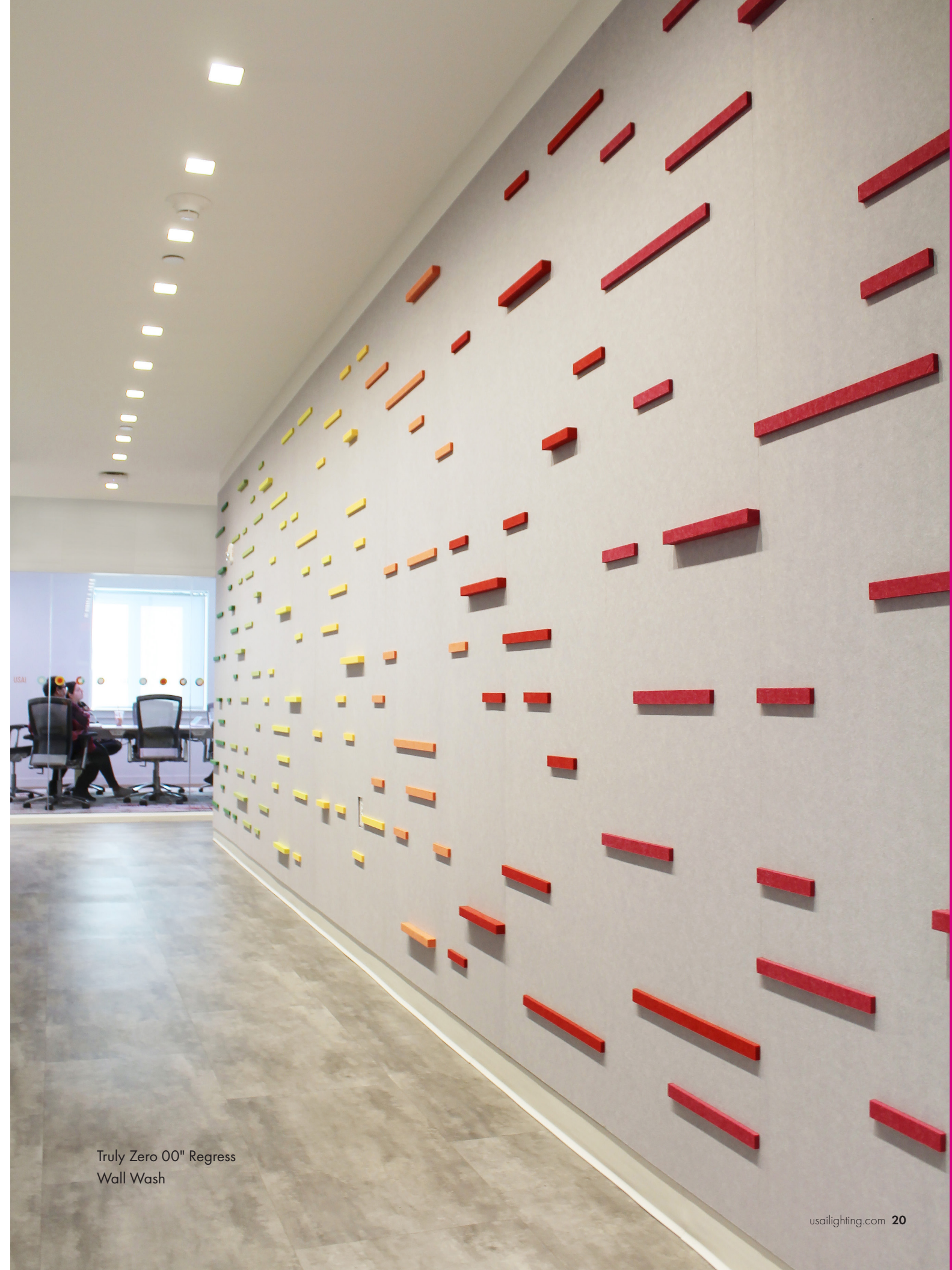

Truly Zero 00" Regress Wall Wash

COMPLEMENTARY USAI PRODUCTS

USAI Lighting believes in the power of innovating for small, whether it is housings, recessed downlights, or surface mounts and pendants. Mix and match **TrueZero³⁶⁰** with other USAI high-performance product ranges. Each product has its own set of capabilities with full family offerings to address every design requirement with the greatest flexibility from space-to-space.

SHALLOW HOUSINGS

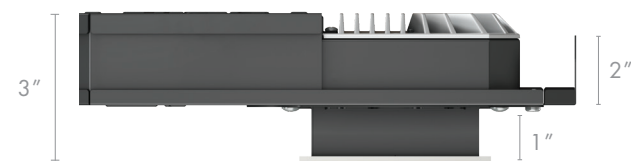

BabyLED[®]
3" aperture



BeveLED Mini[®] Basic Pancake™
3" aperture

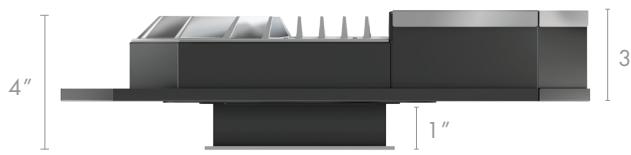

BeveLED[®] Flat FT
4.5" aperture

RECESSED DOWNLIGHTS



the LittleOnes[®] Micro
1.25"



the LittleOnes[®] Micro Doubles
1.25"



Micro Multi-Cell
1.25" cells



True03™
3"



BeveLED Mini[®]
3"



TrueZero04™
4"

SURFACE MOUNTED + PENDANTS



Micro Pendant
1.25" cells



BeveLED Mini[®] 3.5"
(Square)

FAQs

Q: How can I choose between the flat glass version and the regressed lens?

A: The Truly Zero flat glass (00" regress) aligns with the ceiling plane which creates a seamless, minimalistic below-ceiling appearance. Also, the flat glass option is aesthetically identical between downlight, adjustable and wall wash, which helps maintain visual consistency in the ceiling even when the light fixture functions may be different. When the lights are off, the Truly Zero 00" regress keeps a uniform, monolithic surface. This trim is available with a white or black edge detail for smooth integration with light and dark ceilings.

The Truly Subtle 3/8" regress lens trim with black baffle finish provides the lowest glare rating available. The below ceiling appearance of this trim style is closer to that of a traditional downlight, while still providing all the performance and benefits of the Quiet Comfort™ Optics optical system. The white baffle finish is brighter and can provide the highest light levels possible.

Q: What design challenges can this fixture help resolve?

A: The Quiet Comfort Optics for the wall wash optical system is extremely forgiving. For an odd geometry like a soffit, you will be able to mount the fixture as close as 12 inches away from the wall. The downlights can provide highly efficient light levels with flexibility in fixture placement and low to no glare. In finished installations, the full TrueZero³⁶⁰ family forms a flat and seamless ceiling plane with a modern aesthetic.

Q: Can the trim be painted to match the ceiling finish color?

A: The Truly Zero 00" regress trims are available with white and black edge details for seamless integration with both light and dark ceilings. Since there is no flange, no painting to match is necessary.

The Truly Subtle 3/8" regress trims are also available with white and black flange options.

Q: Which control systems are compatible with TrueZero³⁶⁰?

A: As with all USAI Lighting products, TrueZero³⁶⁰ is compatible with every major architectural control system you could choose to use, including 0 - 10V low voltage dimming, line voltage phase dimming, and digital dimming protocols such as DMX and DALI.

Q: Can I place TrueZero³⁶⁰ in wet locations such as showers and outdoor covered spaces?

A: Yes! The TrueZero³⁶⁰ family is UL dry/damp/wet location rated and can be installed outdoors under covered ceilings.

Q: Can I change the TrueZero³⁶⁰ LED color and beam spread from below?

A: Yes! Optics, LEDs and dimming drivers are field interchangeable. If a change is desired in any of these components, USAI's engineering has made this access easy and painless.

Q: Can I use TrueZero³⁶⁰ to meet my project's code requirements?

A: Yes! As with all USAI Lighting fixtures, this product family is NRTL/CSA-US tested to UL standards and IBEW union made. TrueZero³⁶⁰ is Dry/Damp/Wet location listed and is rated for use in steam rooms and saunas, up to 15W maximum, and is UL2043 rated for use in air handling plenums. We offer many Airtight housing options, as well as Insulation Contact and Chicago Plenum rated housings. TrueZero³⁶⁰ can be used to meet Title 24, JAB Certified, LEED and WELL Building requirements. In addition, all USAI Lighting products are Buy American Act (BAA) compliant. If your project requires something else not listed here, please contact us!

TrueZero³⁶⁰TM

TRULY QUIET BELOW-CEILING APPEARANCE



USAI[®]
Lighting

CALL, EMAIL, OR VISIT [USAILIGHTING.COM](https://www.usailighting.com) TO LEARN MORE

USAI LIGHTING COLLABORATORY

13 CROSBY STREET
NEW YORK, NY 10013
(845) 234-4090
SHOWROOM@USAILIGHTING.COM

USAI LIGHTING HEADQUARTERS

1126 RIVER ROAD
NEW WINDSOR, NY 12553
(845) 565-8500
INFO@USAILIGHTING.COM

©2023 USAI, LLC. All rights reserved.
USAI, Classic White, Warm Glow, Color Select and Infinite Color+, the LittleOnes, BeveLED Mini, BabyLED, and BeveLED are registered trademarks of USAI LLC. TrueZero360, True03, True04 and Pancake are trademarks of USAI, LLC
All designs protected by copyright.
Covered by US Patents. Patents pending CA-159